



SERIE NP/NPH/NPX SELLADAS Y RECARGABLES BATERIAS DE PLOMO-ACIDO



SERIE NPH

Tipo	Tipo FR*	Volts	Capacidad Nominal (10 hr rate - Ah)	Largo		Ancho		Altura Total Inc. Terminales		Peso		Layout	Terminales
				mm.	(in.)	mm	(in.)	mm.	(in.)	kgs.	(lbs.)		
NPH2-12	NPH2-12FR	12	2.0	68.0	2.68	51.0	2.01	88.0	3.46	0.84	1.85	2	A
NPH3.2-12	NPH3.2-12FR		3.2	134.0	5.28	67.0	2.64	64.0	2.52	1.40	3.09	3	A
NPH5-12	NPH5-12FR		5.0	90.0	3.54	70.0	2.75	106.0	4.17	2.00	4.41	1	D

Regimen 20hr (Ah)

SERIE NP

NP4.2-4H	-	4	4.2	48.0	1.89	35.5	1.40	119.0	4.68	0.56	1.23	6	-
NP1.2-6	NP1.2-6FR	6	1.2	97.0	3.82	25.0	0.98	54.5	2.15	0.30	0.66	1	A
NP3-6	-		3.0	134.0	5.28	34.0	1.33	64.0	2.52	0.65	1.43	1	A
NP4-6	-		4.0	70.0	2.76	47.0	1.85	105.5	4.15	0.85	1.87	5	A
NP7-6	NP7-6FR	6	7.0	151.0	5.95	64.0	1.33	97.5	3.84	1.35	2.98	1	A/D
NP10-6	NP10-6FR		10.0	151.0	5.95	50.0	1.97	97.5	3.84	2.00	4.41	1	A/D
NP0.8-12	NP0.8-12FR**		0.8	96.0	3.78	25.0	0.98	61.5	2.42	0.35	0.77	7	I
NP1.2-12	NP1.2-12FR	12	1.2	97.0	3.82	48.0	1.89	54.5	2.15	0.57	1.25	3	A
NP2-12	-		2.0	150.0	5.91	20.0	0.79	89.0	3.50	0.70	1.54	8	B
NP2.3-12	NP2.3-12FR		2.3	178.0	7.01	34.0	1.34	64.0	2.52	0.94	2.07	1	A
NP2.6-12	NP2.6-12FR		2.6	134.0	5.28	67.0	2.64	64.0	2.52	1.12	2.47	3	A
NP4-12	NP4-12FR		4.0	90.0	3.54	70.0	2.76	106.0	4.17	1.70	3.74	1	A/D
NP7-12	NP7-12FR		7.0	151.0	5.94	65.0	2.56	97.5	3.84	2.65	6.17	4	A/D
NP12-12	NP12-12FR		12.0	151.0	5.94	98.0	3.86	97.5	3.84	4.00	8.82	4	D
NP18-12B	NP18-12BFR		17.2	181.0	7.13	76.2	2.99	167.0	6.57	6.20	13.64	2	E
NP24-12	NP24-12FR		24.0	166.0	6.54	175.0	6.89	125.0	4.92	8.65	19.05	2	C
NP24-12B	NP24-12BFR		24.0	166.0	6.54	175.0	6.89	125.0	4.92	8.65	19.05	2	E
-	NP26-12B		26.0	166.0	6.54	125.0	4.92	175.0	6.89	9.30	20.50	2	J
-	NP26-12R		26.0	166.0	6.54	125.0	4.92	175.0	6.89	9.30	20.50	2	K
-	NP38-12B		38.0	197.0	7.74	165.0	6.50	175.0	6.89	13.80	30.40	2	F
-	NP38-12R		38.0	197.0	7.74	165.0	6.50	175.0	6.89	13.80	30.40	2	K
NP65-12	NP65-12FR		65.0	350.0	13.78	166.0	6.54	174.0	6.85	22.80	50.20	2	G

W/Celda A 1.67 V Final (Regimen 15 min.)

SERIE NPX

NPX-50	NPX-50FR	6	50W/Cell	151.0	5.95	50.0	1.97	97.5	3.84	2.00	4.41	1	A/D
NPX-25	NPX-25FR	12	23W/Cell	90.0	3.54	70.0	2.75	106.0	4.17	2.00	4.41	1	D
-	NPX-100B		95W/Cell	166.0	6.54	125.0	4.92	175.0	6.89	9.30	20.80	2	J
-	NPX-100R		95W/Cell	166.0	6.54	125.0	4.92	175.0	6.89	9.30	20.80	2	K
-	NPX-150B		150W/Cell	197.0	7.76	165.0	6.50	175.0	6.89	15.50	34.10	2	J
-	NPX-150R		150W/Cell	197.0	7.76	165.0	6.50	175.0	6.89	15.50	34.10	2	K

NOTAS:

* FR: UL94-VO, Caja y Tapa Antiflama (Indice de Oxigeno; 30)
** FR: UL94-V2, Caja y Tapa Antiflama (Indice de Oxigeno; 30)

† Reconocido por UL, File No. MH 12970
- Hecho en Los EEUU (Hays, KS) - UL File No. MH16464

La marca Yuasa de baterías selladas, ha establecido desde su introducción las normas de calidad y excelencia en el ámbito de la tecnología para baterías de plomo-ácido recargables y selladas. Este estándar ha sido utilizado como único en aplicaciones, tales como; seguridad, sistemas de energía ininterrumpida (UPS), telecomunicaciones, iluminación de emergencia y equipamiento médico. En cualquier lugar, donde se requiera energía para back-up en forma eficiente y confiable, Yuasa ocupa el espacio.

La línea de productos NP de marca Yuasa, cubre todo el espectro del tamaño de baterías, desde 0.8 Ah hasta 65 Ah en 4,6 y 12 volts. Yuasa también ofrece una línea completa de baterías antilama (UL94-V0, LOI 30). Designadas como 'FR', estas baterías cumplen con las especificaciones, UL1778 para retardo de llamas en sistemas UPS y con los requerimientos de Bellcore para telecomunicaciones.

Yuasa también ofrece las series de baterías NPX y NPH, diseñadas para aplicaciones con descargas de alto régimen. Estas baterías se utilizan fundamentalmente cuando se requiere gran potencia en un corto tiempo. Con un 50% más de potencia disponible y un 30% de menos tamaño que las baterías convencionales, las series NPX y NPH ofrecen un valor superior, especialmente en las aplicaciones para sistemas UPS.

SERIE NPX - WATTS POR CELDA HASTA 1.67 V FINAL

	5 MIN	10 MIN	15 MIN	20 MIN
NPX-25	47	31	23	18
NPX-50	94	60	50	38
NPX-35	66	45	35	29
NPX-80	140	104	80	65
NPX-100	185	125	95	75
NPX-150	285	200	150	120

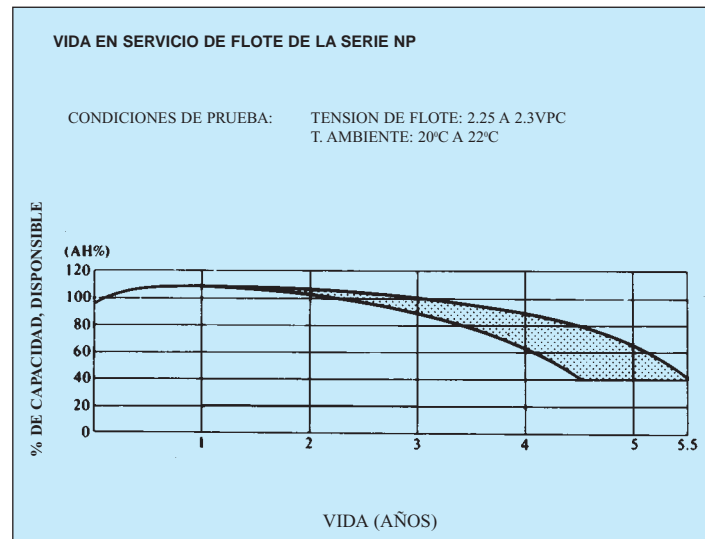
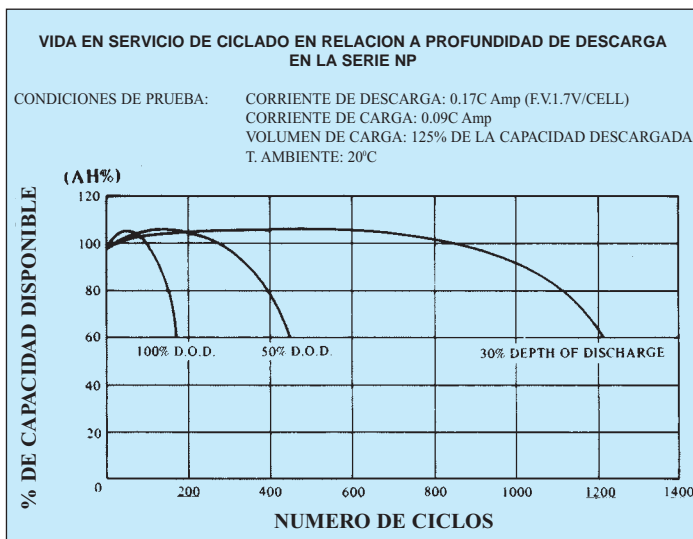
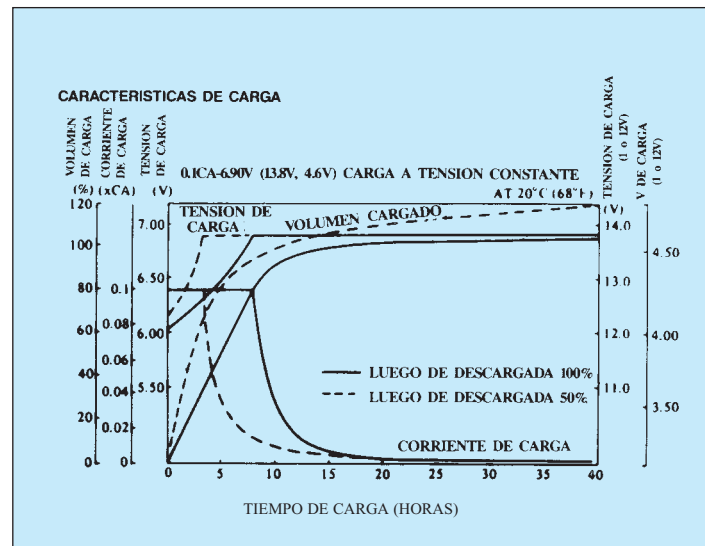
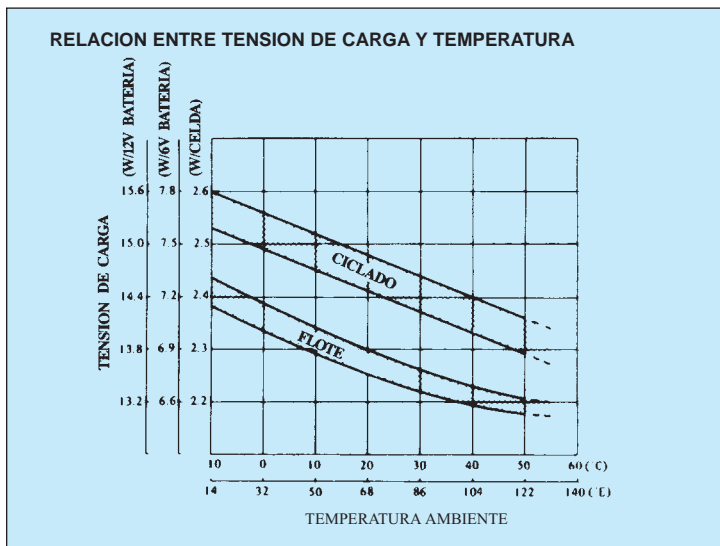

CURVAS DE DESCARGA A 20°C (68°F)

SERIE NP

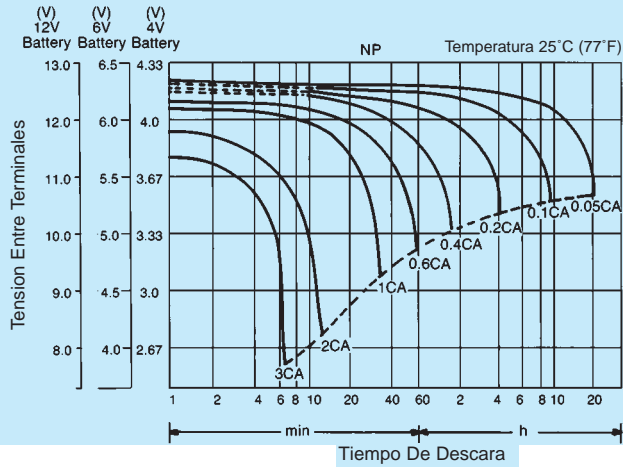

SERIE NPH

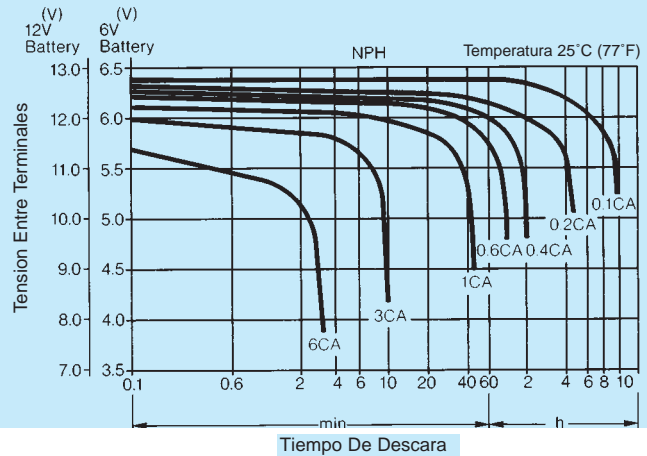

• Si se requiere corriente de descarga de mas de 3 veces la corriente nominal consulte al Servicio Tecnico de Enersystem antes de su utilización.

Notas importantes para prolongar la vida de la bateria:

■ Carga

- Uso standby: Aplicar v constante a 2.275 v por celda (0 2.25-2.30 vpc).
- Uso ciclado: Aplicar v constante a 2.40-2.50 v por celda
La corriente inicial de carga debe ser menor a 0.25 CA.
- Almacenaje de 6 meses: cargar a una tension constante de 2.40 volts por celda.
La corriente inicial de carga debe ser menor a 0.1 CA por 15 a 20 horas.

■ Descarga

- Interrumpir la descarga al llegar a la tension minima permitida recargar inmediatamente.
- No operar a mas de 6 veces la corriente nominal.

■ Almacenaje

- Almacenar siempre la bateria totalmente cargada.
- Si la bateria debe ser almacenada por un largo periodo de tiempo, recargar cada 6 meses.

■ Temperatura

- Mantener a t ambiente entre - 15°C y + 50°C tanto para la carga como para la descarga.
- Almacenar las baterias en un lugar calido y seco.

■ Incorporacion de la bateria en equipos

- Colocar la bateria en un lugar bien ventilado.
- Evite instalar la bateria cerca de unidades que liberen calor, como ser un transformador.
- Coloque la bateria en la parte mas baja del equipo para evitar el calentamiento.

■ Otros

- Evite los cortocircuitos o fuegos cercanos.
- No exponer a llama.
- Evite el contacto de la bateria con gasolina, solventes, resinas sinteticas, thinner, aceites, etc.

TENSION FINAL DE DESCARGA

Corriente de descarga	Voltaje final de descarga (V/celda)
0.1 C o menor, o descargas intermitentes	1.75
0.1 7C o corriente cercana a esta	1.70
0.26C o corriente cercana a esta	1.67
0.6C o corriente cercana a esta	1.60
Desde 0.6C a 3	1.50
Corriente en exceso (>3C)	1.30

• LAYOUT

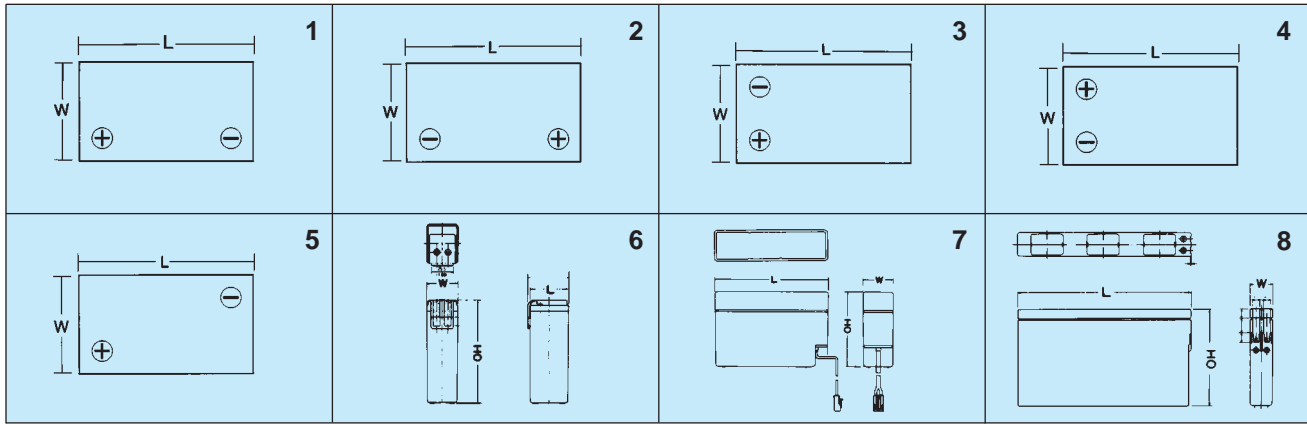

• TERMINAL

<table border="1"> <thead> <tr> <th colspan="2">INCH = MM</th> </tr> </thead> <tbody> <tr><td>.250</td><td>6.35</td></tr> <tr><td>.185</td><td>4.70</td></tr> <tr><td>.124</td><td>3.15</td></tr> <tr><td>.098</td><td>2.50</td></tr> <tr><td>.059</td><td>1.50</td></tr> <tr><td>.031</td><td>0.80</td></tr> <tr><td>.020</td><td>0.50</td></tr> <tr><td>.004</td><td>0.10</td></tr> </tbody> </table> <p>Faston tab : 187 A</p>	INCH = MM		.250	6.35	.185	4.70	.124	3.15	.098	2.50	.059	1.50	.031	0.80	.020	0.50	.004	0.10	<table border="1"> <thead> <tr> <th colspan="2">INCH = MM</th> </tr> </thead> <tbody> <tr><td>0.472</td><td>12.00</td></tr> <tr><td>0.250</td><td>6.35</td></tr> <tr><td>0.236</td><td>6.00</td></tr> <tr><td>0.185</td><td>4.70</td></tr> <tr><td>0.079</td><td>2.00</td></tr> <tr><td>0.020</td><td>0.50</td></tr> </tbody> </table> <p>Faston tab: 187 B</p>	INCH = MM		0.472	12.00	0.250	6.35	0.236	6.00	0.185	4.70	0.079	2.00	0.020	0.50	<table border="1"> <thead> <tr> <th colspan="2">INCH = MM</th> </tr> </thead> <tbody> <tr><td>.250</td><td>6.35</td></tr> <tr><td>.124</td><td>3.15</td></tr> <tr><td>.098</td><td>2.50</td></tr> <tr><td>.059</td><td>1.50</td></tr> <tr><td>.031</td><td>0.80</td></tr> <tr><td>.020</td><td>0.50</td></tr> </tbody> </table> <p>Faston tab :250 C</p>	INCH = MM		.250	6.35	.124	3.15	.098	2.50	.059	1.50	.031	0.80	.020	0.50
INCH = MM																																																
.250	6.35																																															
.185	4.70																																															
.124	3.15																																															
.098	2.50																																															
.059	1.50																																															
.031	0.80																																															
.020	0.50																																															
.004	0.10																																															
INCH = MM																																																
0.472	12.00																																															
0.250	6.35																																															
0.236	6.00																																															
0.185	4.70																																															
0.079	2.00																																															
0.020	0.50																																															
INCH = MM																																																
.250	6.35																																															
.124	3.15																																															
.098	2.50																																															
.059	1.50																																															
.031	0.80																																															
.020	0.50																																															
<table border="1"> <thead> <tr> <th colspan="2">INCH = MM</th> </tr> </thead> <tbody> <tr><td>.310</td><td>7.90</td></tr> <tr><td>.250</td><td>6.35</td></tr> <tr><td>.16</td><td>4.0</td></tr> <tr><td>.031</td><td>0.8</td></tr> <tr><td>.020</td><td>0.5</td></tr> </tbody> </table> <p>Faston tab 250 D</p>	INCH = MM		.310	7.90	.250	6.35	.16	4.0	.031	0.8	.020	0.5	<table border="1"> <thead> <tr> <th colspan="2">INCH = MM</th> </tr> </thead> <tbody> <tr><td>.472</td><td>12.00</td></tr> <tr><td>.453</td><td>11.50</td></tr> <tr><td>.433</td><td>11.00</td></tr> <tr><td>.216</td><td>5.50</td></tr> <tr><td>.079</td><td>2.00</td></tr> </tbody> </table> <p>Bolt fastened terminal E</p>	INCH = MM		.472	12.00	.453	11.50	.433	11.00	.216	5.50	.079	2.00	<table border="1"> <thead> <tr> <th colspan="2">INCH = MM</th> </tr> </thead> <tbody> <tr><td>.669</td><td>17.0</td></tr> <tr><td>.216</td><td>5.5</td></tr> <tr><td>.295</td><td>7.5</td></tr> <tr><td>.197</td><td>5.0</td></tr> </tbody> </table> <p>Bolt fastened terminal F</p>	INCH = MM		.669	17.0	.216	5.5	.295	7.5	.197	5.0												
INCH = MM																																																
.310	7.90																																															
.250	6.35																																															
.16	4.0																																															
.031	0.8																																															
.020	0.5																																															
INCH = MM																																																
.472	12.00																																															
.453	11.50																																															
.433	11.00																																															
.216	5.50																																															
.079	2.00																																															
INCH = MM																																																
.669	17.0																																															
.216	5.5																																															
.295	7.5																																															
.197	5.0																																															
<table border="1"> <thead> <tr> <th colspan="2">INCH = MM</th> </tr> </thead> <tbody> <tr><td>0.24</td><td>6</td></tr> <tr><td>0.27</td><td>7</td></tr> <tr><td>0.37</td><td>9.5</td></tr> <tr><td>0.71</td><td>18</td></tr> <tr><td>0.768</td><td>19.5</td></tr> </tbody> </table> <p>Bolt fastened terminal G</p>	INCH = MM		0.24	6	0.27	7	0.37	9.5	0.71	18	0.768	19.5	<p>WIRE AWG \approx 20 UL 1007</p> <p>JST VHR-2N (TERMINAL)</p> <p>JST SVH-21T-P1.1</p> <p>JST No. VHR-2N </p>	<p>(Lug) TERMINAL (inches)</p> <p>Bolt fastened terminal J</p>																																		
INCH = MM																																																
0.24	6																																															
0.27	7																																															
0.37	9.5																																															
0.71	18																																															
0.768	19.5																																															
<p>UNF#10-32</p> <p>Threaded Receptacle K</p>	<div style="display: flex; justify-content: space-around; align-items: center;"> </div> <div style="text-align: right;"> <p>Website: www.enersystem.com</p> <p>E-mail: info@enersystem.com</p> <p>EnerSystem: Tel.: +54-11-4736-3000</p> <p>Fax: +54-11-4736-3200</p> </div>																																															

Distribuido Por: